

ÁLLÍTHATÓKULCSOK

90-es sorozat, foszfátzott



9072



9072P

90 ergo®

mm		
158x20	5	9070
158x21	5	9070 P
208x27	5	9071
208x28	5	9071 P
257x31	5	9072
257x33	5	9072 P
308x34	5	9073
308x35	5	9073 P



9029/9031 ergo®

mm		
170x32	5	9029
218x38	5	9031

90-es sorozat, krómozott



9072 C



9072 PC

90C ergo®

mm		
158x20	5	9070C
158x21	5	9070 PC
208x27	5	9071C
208x28	5	9071 PC
257x31	5	9072 C
257x33	5	9072 PC
308x34	3	9073 C
308x35	3	9073 PC

90-es sorozat, krómozott



9029C/9031C ergo®

mm		
170x32	5	9029 C
218x38	5	9031 C

80-as sorozat, foszfátzott



8070

80

mm		
110x13	5	8069
155x20	5	8070
205x27	5	8071
255x30	5	8072
305x34	5	8073
380x44	3	8074
455x53	3	8075
110x13	50	8069 IP
155x20	40	8070 IP
205x27	50	8071 IP
255x30	30	8072 IP
305x34	20	8073 IP
380x44	20	8074 IP
455x53	12	8075 IP

80-as sorozat, krómozott



8069C - 8075C

80C

mm		
110x13	5	8069 C
155x20	5	8070 C
205x27	5	8071 C
255x30	5	8072 C
305x34	3	8073 C
380x44	3	8074 C
455x53	3	8075 C
110x13	5	8069 C IP
155x20	5	8070 C IP
205x27	5	8071 C IP
255x30	5	8072 C IP
305x34	3	8073 C IP
380x44	3	8074 C IP
455x53	3	8075 C IP

Tradicionális modellek, foszfátzott



31



86 - 87

31/86/87



mm		
205x32	5	31
614x63	1	86
770x85	1	87
205x32	50	31 IP

ÁLLÍTHATÓ FORGÁSPONTÚ FOGÓK

Állítható forgáspontú fogók



8223 - 8226 ergo®

mm		
200	5	8223
250	5	8224
315	5	8225
400	1	8226
200	5	8223 IP
250	5	8224 IP
315	5	8225 IP
400	1	8226 IP

Állítható forgáspontú fogók





2619LS

mm		
175	5	2619 LS-175
250	5	2619 LS-250
300	5	2619 LS-300

Állítható forgáspontú fogók





221 D - 225 D

mm		
117	5	221 D
150	5	222 D
192	5	223 D
240	5	224 D
305	3	225 D
117	5	221 D IP
150	5	222 D IP
192	5	223 D IP
240	5	224 D IP
305	5	225 D IP

Állítható forgáspontú fogók





8231 ergo®

mm		
225	5	8231
225	5	8231 IP

Állítható forgáspontú fogók







8224/8225C ergo®

mm		
250	5	8224CIP
315	5	8225CIP



KÜLÖNLEGES FOGÓK

Különleges fogó

		
2650	2650 B	
mm		
235	1	2650
	1	2650 B

CSŐFOGÓK





Univerzális csőfogók

		
1410/1420 		
mm-inch		
335 - 1	1	1410
430 - 1 1/2	1	1420

Univerzális csőfogók

		
1175 		
mm-inch		
335 - 1	1	1175-1
430 - 1 1/2	1	1175-11/2

Univerzális csőfogók

		
140-147		
mm-inch		
215-3/4	1	140
280-1	1	141
370-1 1/2	1	142
555-2 1/2	1	143
720-3 1/2	1	144
1060-5	1	147

Sarokcsőfogók

		
442 B-444 B		
mm-inch		
320-1	1	442 B
430-2	1	443 B
535-2 1/2	1	444 B

Csőfogó rögzítő



142-3

mm		
117	5	142-3

Svédfogók, univerzális modell

		
DOW175		
mm-inch		
310-1	1	DOW 175-1
420-1 1/2	1	DOW 175-11/2
560-2	1	DOW 175-2
655-3	1	DOW 175-3

Sarok svédfogók

		
DOW176		
mm-inch		
314-1	1	DOW 176-1
456-1 1/2	1	DOW 176-11/2
570-2	1	DOW 176-2

Kombinált svédfogók





		
DOW177		
mm-inch		
320-1	1	DOW 177-1/2-1
416-1 1/2	1	DOW 177-11/2
535-2	1	DOW 177-2

Kombinált svédfogók

		
341-343		
mm-inch		
230-1/2	1	341
330-1	1	342
420-1 1/2	1	343

CSAPSZEGFOGÓ

Csapszegfogók



		
2979D		
mm		
180/3-13	5	2979 D-180

HUZALBIZTOSÍTÓ FOGÓK

Huzalbiztosító fogók

		
2855		
mm		
224	1	2855

Huzalbiztosító fogók

		
2855D		
mm		
282	1	2855 D

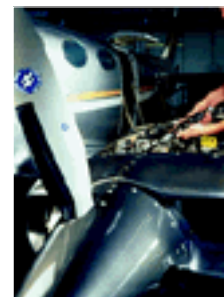

Huzalbiztosító fogók

2855QT

mm
224



1



2855QT

Huzalbiztosító fogók

2855DQT

mm
282



1



2855DQT

Huzalbiztosító fogók

2855R

mm
270



1



2855R

HEGESZTŐ- ÉS GRIPFOGÓK

Huzalvágó gripfogó

2951

mm
180
250
300



1



2951-180

2951-250

2951-300

Huzalvágó gripfogó

2968

mm
235



1



2968-235

Huzalvágó gripfogó

2952

mm
165
235



1



2952-165

2952-235

Párhuzamos gripfogók

2955

mm
250



1



2955-250

Ideal gripfogó

2957

mm
250



1



2957-250

Gripfogó egyenes pofákkal

2958

mm
250



1



2958-250

Gripfogó hegesztéshez

2965

mm
280



1



2965-280

Gripfogó csövekhez

2966

mm
280



1



2966-280

C-szorító

2963

mm
280



1



2963-280

Párhuzamos C-szorító

2964

mm
280



1



2964-280

Gripfogó fémlemezhez

2967

mm
180



1



2967-180

Zárófogók

2985

mm
195



1



2985-195

